

SRF SK-7.5 JET

(55.152)

Voltage	(V)	400	max. neg. pressure	(Pa)	25.000
Motor	(kW)	7,5	max. air flow	(m ³ /h)	850
Filter surface	(m ²)	15	Weight	(kg)	230
Rated frequency	(Hz)	50	Intake diameter	(mm)	100
Mode of operation		S1	Dimensions (L x B x H)	(mm)	1.690 x 780 x 1.300
Filter cleaning		Jet-Pulse	Dust collection bin	(liter)	30

*at 4 bar with valve opening 0,12 sec

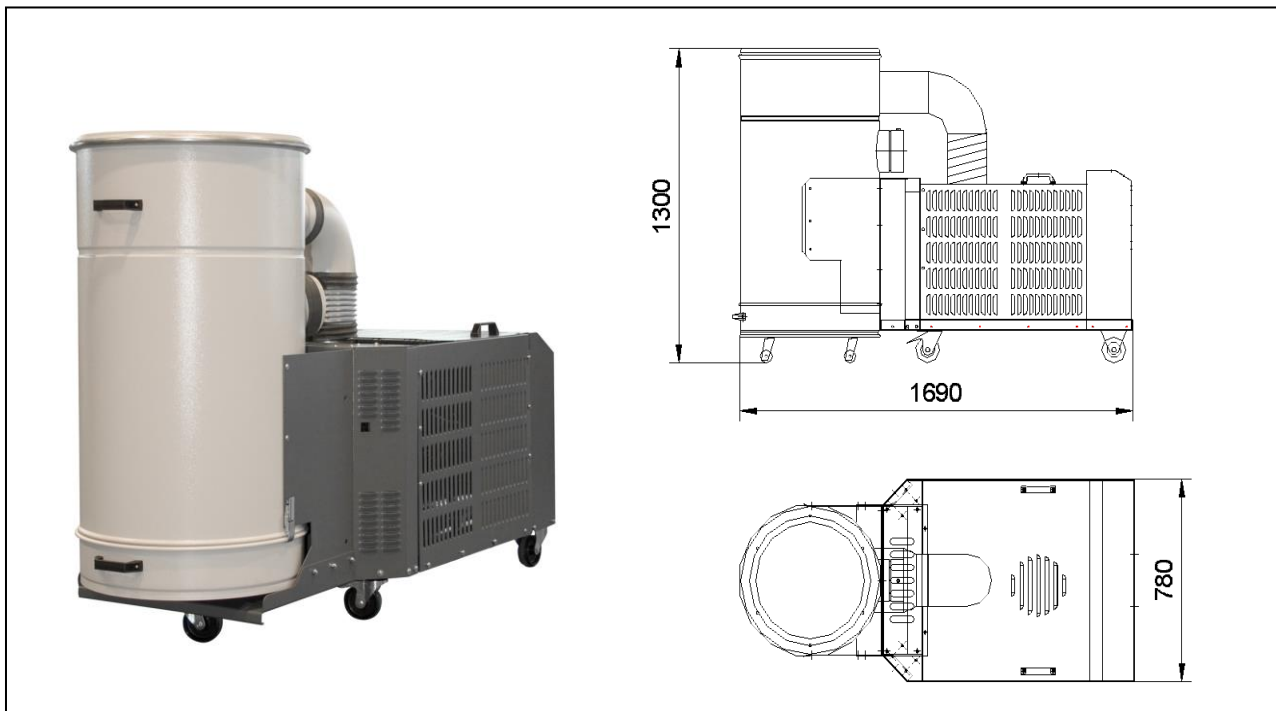

ESTA PLUS

Application Range:

- Intermittent and continuous duty operation
- Direct extraction at the welding torch
- Welding extraction of non-alloy steels

Your benefits at a glance:

- High suction power for direct extraction at the welding torch
- Designed with side channel blower for continuous duty operation
- Low operating costs through the use of cleanable
- long life cartridge filters (dust classification „M“)

Characteristic:

- Filter cleaning with automatic pulse-jet filter cleaning system

Modifications:

- Special voltage
- Special equipment with pulse jet filter cleaning
- Special painting
- Exhaust air connection
- Different filter material

State of the art: 55152-51-00 Subject to change without notice! For remaining questions, please do not hesitate to contact us.