

SRF SK-5.5 FA

(55.162)

Voltage	(V)	400	max. neg. pressure	(Pa)	24.500
Motor	(kW)	5,5	max. air flow	(m ³ /h)	480
Filter surface	(m ²)	15	Weight	(kg)	230
Rated frequency	(Hz)	50	Intake diameter	(mm)	70
Mode of operation		S1	Dimensions (L x B x H)	(mm)	1.690 x 780 x 1.300
Filter cleaning	pneumatic (autom.)		Dust collection bin	(liter)	30

*at 4 bar with valve opening 0,12 sec

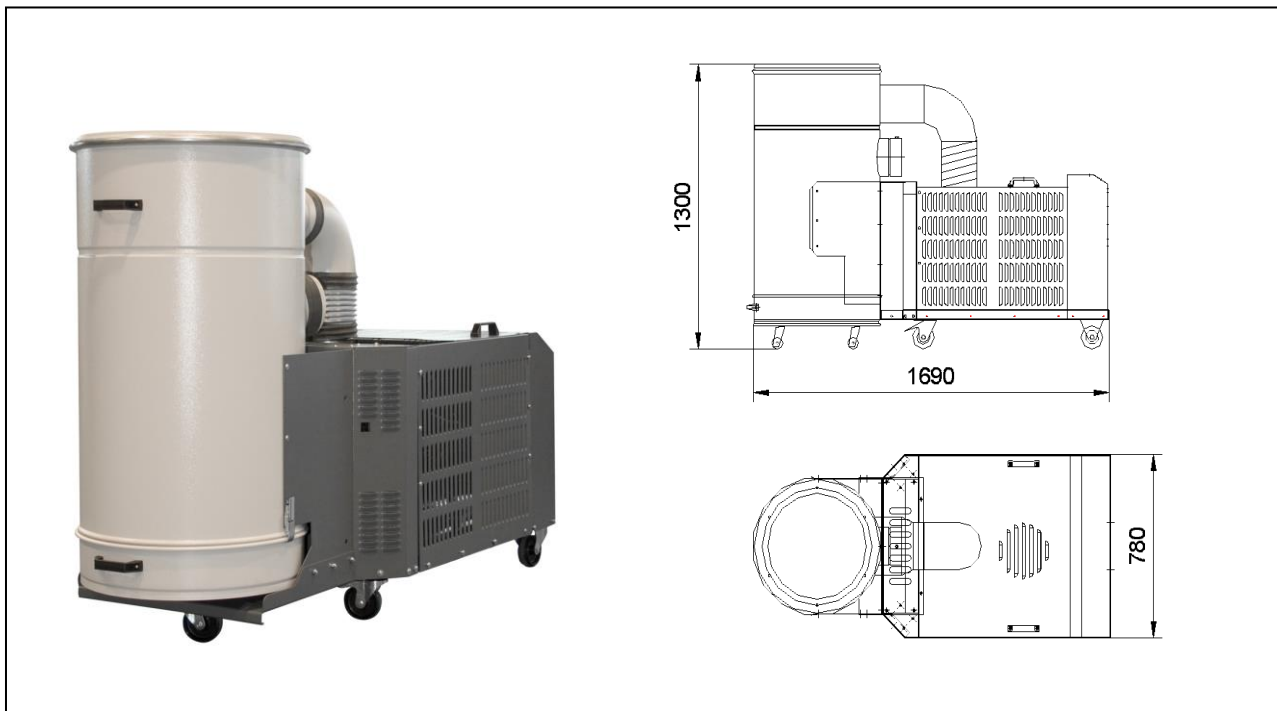

ESTA PLUS

Application Range:

- Intermittent and continuous duty operation
- Direct extraction at the welding torch
- Welding extraction of non-alloy steels

Your benefits at a glance:

- High suction power for direct extraction at the welding torch
- Designed with side channel blower for continuous duty operation
- Low operating costs through the use of cleanable
- long life cartridge filters (dust classification „M“)
- Convenient disposal of the dust

Characteristic:

- Filter cleaning with pneumatic filter cleaning (automatic)

Modifications:

- Special voltage
- Special equipment with pulse jet filter cleaning
- Special painting
- Exhaust air connection
- Different filter material

State of the art: 55162-51-00 Subject to change without notice! For remaining questions, please do not hesitate to contact us.