

ESTA

THE WORLD OF EXTRACTION



FILTOWER

THE AMBIENT AIR FILTRATION SYSTEM FOR
WELDING FUMES, DUST & OIL MIST

www.esta.com/en/filtower

FILTOWER ambient air filtration system

Unique: the filter tower technology from ESTA

The FILTOWER series is the ideal solution, if source collection of fumes, dust or oil emulsion mist alone is insufficient or direct collection is not practical, when working on large or complex workpieces.

Available in three performance levels, the towers ensure noticeably improved air quality, depending on the size of the facility.

Plug & Play:

Quick and easy to install

The filter towers do not require a duct system and can be put into operation in no time, according to the "plug & play" principle: set up, connect electrical power and compressed air, done!

And because the towers can be arranged flexibly in the manufacturing areas, they are highly suitable for changing workplaces

3 Various Applications

FILTOWER-F – *Welding fume*
FILTOWER-D – *Dust*
FILTOWER-L – *Oil- & Emulsion mist*

3 Various performance Levels

FILTOWER-100 – *7,000 cfm*
FILTOWER-160 – *10,000 cfm*
FILTOWER-200 – *13,000 cfm*



Layered ventilation principle: Saves heating costs

FILTOWERS from ESTA work according to the principle of layered ventilation recommended by the trade associations: they suck in the polluted air at the top of the system, filter it and direct the cleaned air close to the floor with minimal drafts directly into the working areas. Complete recirculation of the purified air saves companies up to 70% on heating costs in the cold season.

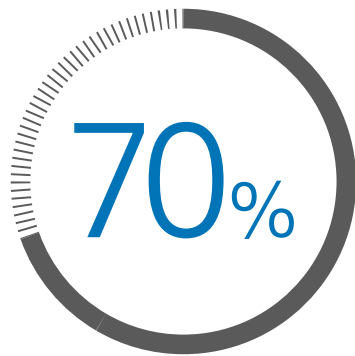

Dust limit values firmly under control

FILTOWER ambient air filtration systems offer a twofold advantage: they effectively improve air quality for employees in manufacturing areas and make an important contribution to complying with the statutory exposure limit values.

In practice, the filter towers have often proved to be a useful support for existing collection devices, particularly since occupational exposure limits of regulated respirable fractions were drastically reduced.

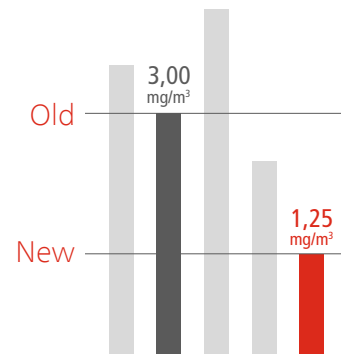

More powerful, more energy efficient and quieter than ever

The new ESTA filter towers come standard equipped with EC fans, which underlines their aim to be the most powerful, energy-efficient and quietest towers on the market.



Highly efficient & economical

Users can control the volume flow as needed. This reduces the power consumption of the towers significantly. Compared to commercially available filter towers, which are equipped with radial fans, FILTOWERS achieve power savings of up to 50%.

Low operating noise

ESTA also sets new standards in terms of noise level due to optimized air circulation and particularly quiet fans: at a maximum between 70 and 77 dB(A), FILTOWERS are extremely quiet in operation and thus ensure a pleasant working environment.

Top-Performance

The new generation is available in three power levels up to a maximum airflow of 13,000 cubic feet per minute.

ESTA EASYCONTROL SYSTEM CONTROL

ESTA's own EasyControl system allows efficient and controllable operation of the system for all versions of the FILTOWER, assuring optimal processing of the sensor signals.



Multi-stage filter system. The result: pure air

1

Extraction of polluted air

2

Pre-separation system for
the filtration of coarse particles

3

Main filtration with
separation efficiency 99.95 %

4

Low-draft clean air return

5

Simple filter change with the
ESTA quick-change filter system

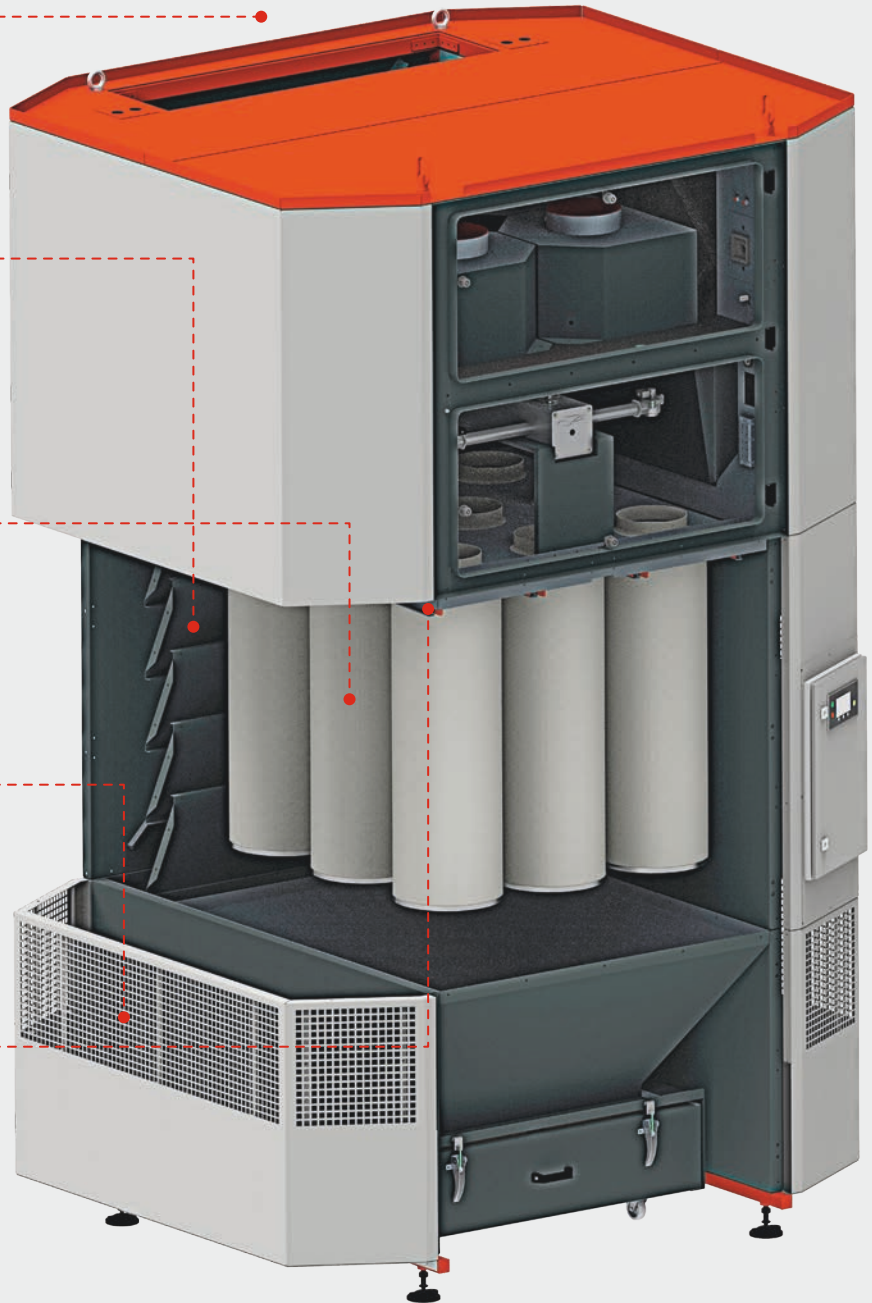

Fast installation, easy handling – the focus is on production

Housing construction

The sound-insulated housing construction and low-draft clean air outlets ensure a pleasant working environment, even directly at the system.

Filter change system

The new **ESTA QuickChange filter replacement system** provides a dust-free and time-saving replacement method of the filter cartridges.



Cleanable filter cartridges*

The durable polyester spun-bonded fabric filter material is cleaned fully automatically during operation by means of compressed air to remove any adhering debris, resulting in low operating costs. This achieves continuous extraction at low operating costs.

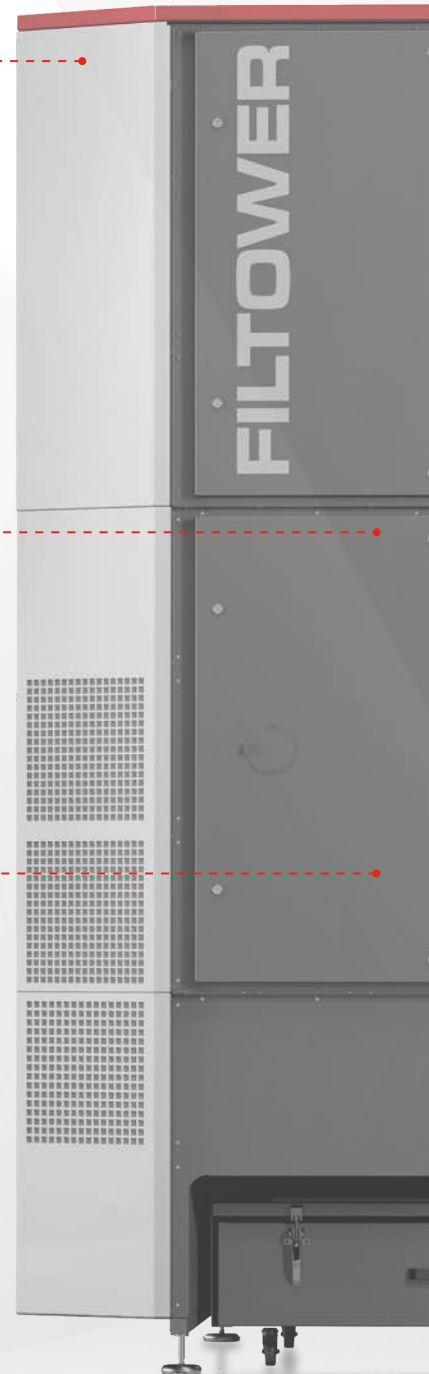
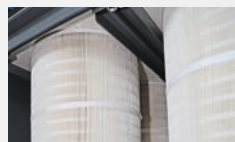



Fans



The new generation filter towers are equipped with highly efficient EC fans for controllable and therefore energy-saving system operation.

Intuitive control



The heart of the control system is the ESTA EasyControl system. It allows efficient device operation with optimal processing of sensor signals.

Dust removal



After the filtration process, the separated dust particles fall into a mobile 42.27 gal drawer below the filter chamber. Two collecting boxes inside are sealed with a lid before removal, which ensures low-dust disposal of the collected material.* A new, additional collection container collects coarse particles and sparks to protect the main filter and minimize the risk of filter fires.

* Depending on device version

The original FILTER TOWER from ESTA

- » Flexible use for welding fumes, dust and oil emulsion mist
- » Better air quality for all employees in manufacturing areas
- » Supports compliance with the occupational exposure limit values
- » Controllable, energy-saving system operation due to highly efficient EC technology
- » Power savings of up to 50 % as a result of the ESTA EasyControl monitoring system
- » Powerful, with up to 13,000 cfm air volume flow
- » Low noise during operation
- » Up to 70 % heating cost savings through recirculation mode
- » Plug & play filter tower: set up, connect electrical power and compressed air – done!
- » No duct installation and assembly work necessary
- » Low operating costs thanks to cleanable permanent filter cartridges



Improved performance

Extraction capacity can be regulated via **ESTA EasyControl**



10% more volume flow than its predecessor



70% heating cost savings through air recirculation mode

Max. 13,000 cfm air volume flow

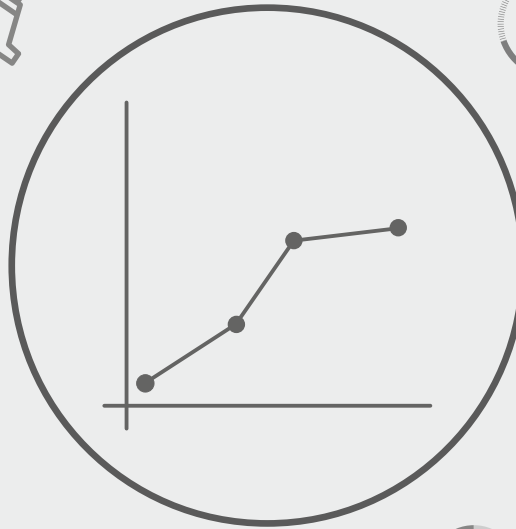

Latest **EC fan technology**



Low noise during operation (77 dB(A) at 13,000 cfm)



Energy-saving system operation

FILTOWER eco⁺

The highest level of efficiency.

When it comes to the energy efficiency of air filtration systems, the eco⁺ series is a real trailblazer: The integrated ESTA EasyControl device control system, combined with sophisticated sensor technology, ensures sustained energy efficiency during extraction operations.

The eco⁺ filter towers do not permanently resort to the maximum possible output, but conform strictly to the currently required air volume flow. Thanks to intelligent sensors and measurement of the volume flow, they automatically adjust performance based on the operating parameters.

Result: A power saving of up to 50 % compared to air filtration systems with conventional device control. This reduces operating costs significantly.

These advantages are offered by the FILTOWER eco⁺:

- » Automatic regulation of air volume flow by means of dust sensors
- » Residual dust and filter breakage monitoring
- » Collection container level measurement
- » Energy-efficient system operation
- » Timer



FILTOWER 4.0

Intelligently networked into the future.

The ambient filtration system in the Industrie 4.0 version has integrated network and protocol functions and can be perfectly incorporated into a 4.0 environment. This is implemented by any data connection such as LAN, WLAN or LTE. Users can access and monitor the most important operating data such as air flow, operating hours or filter status at any location – also by via tablet and smartphone.

This way, companies proactively avoid machine breakdowns that could lead to a standstill in the entire production chain. The measured data shortens the time spent troubleshooting by service technician and spare parts procurement can also be planned more efficiently.

The result is that operating costs are considerably reduced. In addition, all measuring and operating data is permanently logged.

We offer you predictive maintenance together with our partner Advanced Industry Analytics. Contact us at: esta@industry-analytics.com.

These advantages are offered by the FILTOWER 4.0:

- » Simple coupling of the filter tower to company-specific network infrastructure via LAN / WLAN
- » Remote access and monitoring of all operating data worldwide possible, including by the user himself
- » Reduction of the risk of malfunction by permanent logging and monitoring of operating parameters
- » Reduction of maintenance and service costs by remote monitoring and maintenance



FILTOWER ecotemp

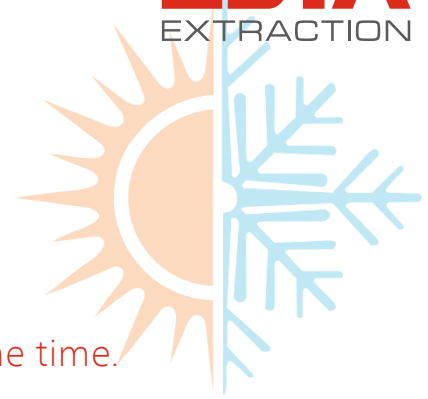

Cleans, cools or heats the shop floor air at the same time.

With the ecotemp filter towers, users regulate the temperature of the filtered air themselves. Depending on the season, cool or warm air flows back into the working area. The ecotemp version is the optimal solution especially for manufacturing areas with a high heat load, such as CNC turning or milling centers: companies benefit from noticeable energy savings, and employees from comfortably air-conditioned work areas all year round.

The cooling air flow also has a positive effect on the machine, tool and parts temperature in terms of productivity and precision. In winter, the ecotemp filter towers provide warm return air. This is particularly useful for companies with frequently opened doors or insufficiently insulated shop floors.

We are happy to help you with the best and most optimal design of your cooling capacity – based on VDI 2078.

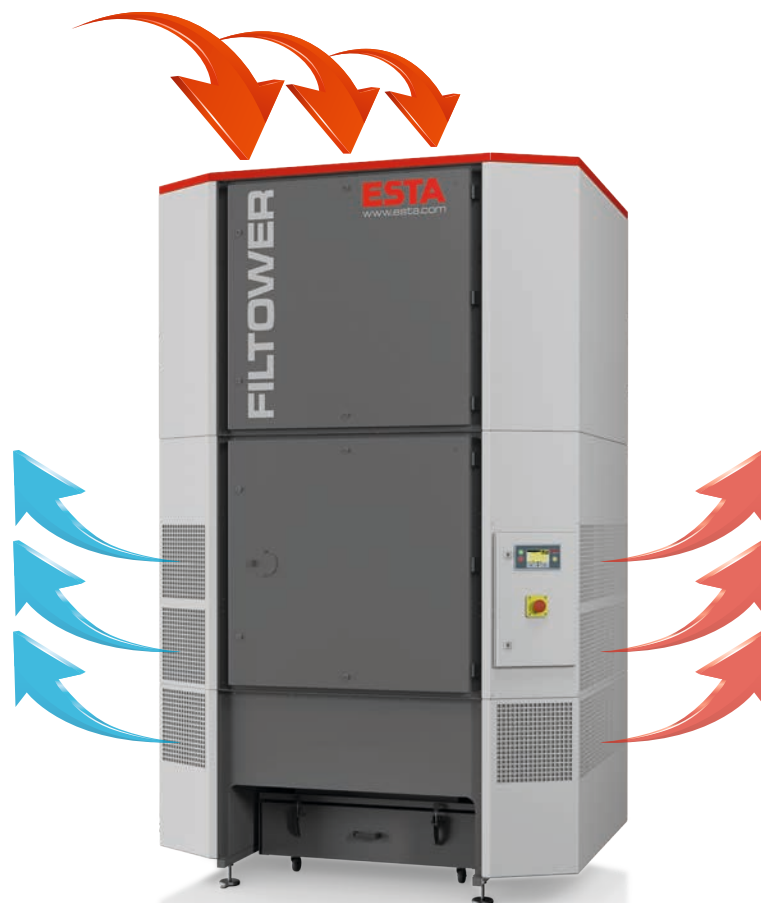

FILTOWER ecotemp

These advantages are offered by the FILTOWER ecotemp:

- » Clean and comfortably temperature-controlled shop floor air
- » Two finned heat exchangers cool or heat the filtered air as needed
- » Infinitely variable temperature control
- » Supports existing air conditioning and heating technology for additional energy savings
- » Environmentally friendly and safe: water circulation system and no need for coolant, connection: 2 × 1 inch
- » Low maintenance due to installation of the heat exchanger on the clean air side
- » Drain valves for condensate
- » Stainless steel drip tray
- » Low pressure loss due to large surface area of the heat exchangers

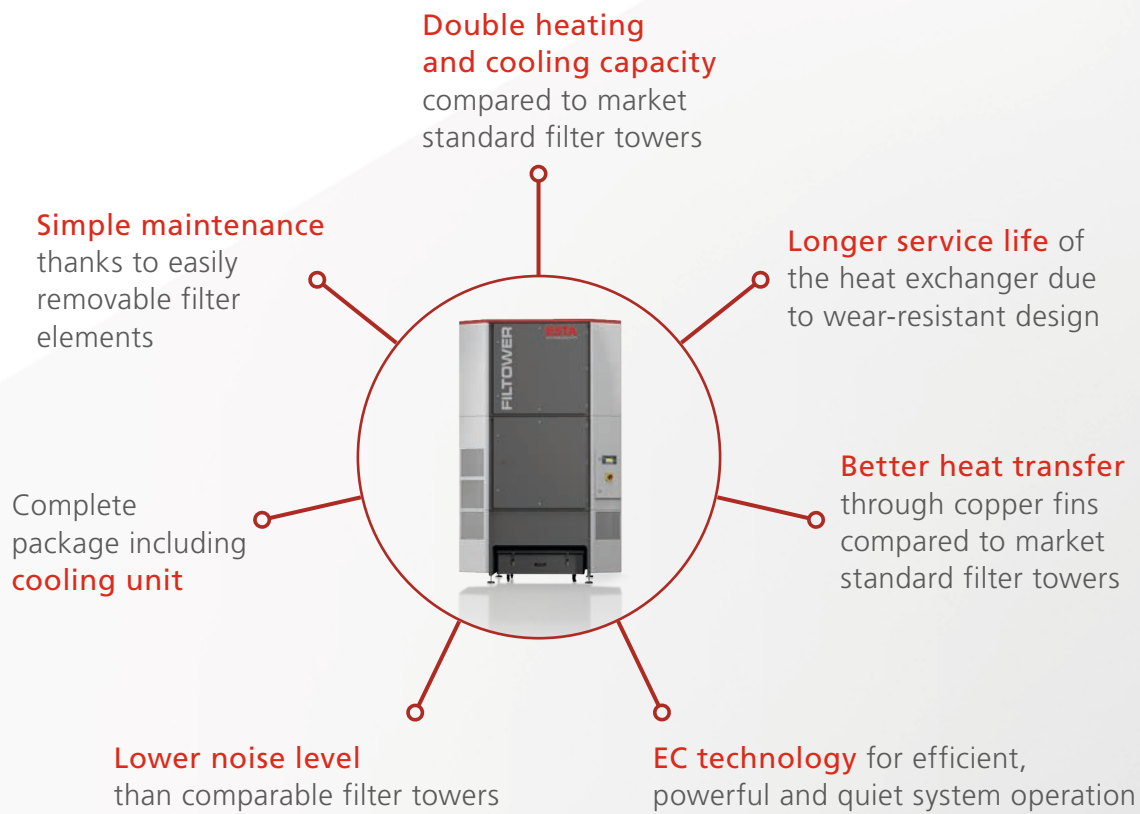

References

Wilhelm Siebelist GmbH & Co. KG, Plaue Metal Industry/Precision Turning

- » Two FILTOWER ecotemp with separate Euro cooler
- » Emission: oil mist
- » 30% state subsidy



„The workshop climate improved significantly last summer and we were able to maintain our process efficiency at a high level.“

Michael Marquardt, Managing Director



Dr.-Ing. Ulrich Esterer GmbH & Co. KG, Helsa Mechanical engineering/vehicle bodies and plants

- » Three FILTOWERS with heating function
- » Emission: welding fumes
- » 30% state subsidy

Pfaff Industrial, Kaiserslautern

Sewing and welding technology/ industrial sewing machines

- » FILTOWER
- » Emission: welding fumes
- » 30% state subsidy

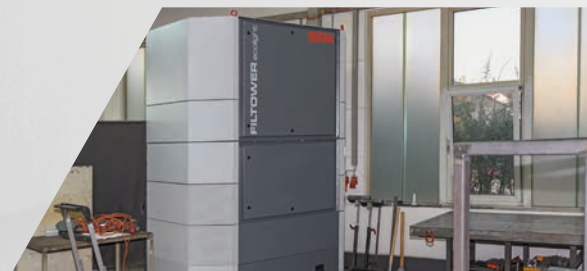

„We are very satisfied with the products and service, and in ESTA, have a supplier who can assist us with all the different applications we have.“

Helmut Pfänder

Head of maintenance, environmental protection, occupational health and safety and operational safety

FILTOWER series at a glance

	Standard	eco ⁺	4.0
Fans with EC motor drive	●	●	●
ESTA EasyControl control system	●	●	●
Simple volume flow control	●	●	●
Jet pulse filter cleaning	●	●	●
ESTA QuickChange filter change system	●	●	●
Timer	●	●	●
Automatic regulation of air volume flow by means of dust sensors	—	●	●
Residual dust and filter monitoring	—	●	●
Dust collection container level measurement	—	●	●
Digital installation aid	●	●	●
Operating data recording	—	○	●
Remote maintenance and control by LAN/WLAN	—	—	●
<i>ecotemp</i> *	○	○	○

● = included ○ = optional — = not included



Technical Data

		Series 100	Series 160	Series 200
Max. Airflow	cfm	7,000	10,000	13,000
Voltage	V	480	480	480
Motor	HP	2×5.0	4×5.0	4×5.0
Filter surface	ft ²	970	1,700	2,422
Filter elements	piece	9	9	9
Dust collection container l		42.27	42.27	42.27
Dimensions (L/W/H)	inch	70.36×82.29×120.24	70.36×82.29×135.91	70.36×82.29×151.74
Weight	lb	2,650	3,100	3,300
Sound emission	dB(A)	70	74.8	77

FILTOWER F 100

eco⁺

ecotemp

4.0

ecotemp + **4.0**

FILTOWER F 160

eco⁺

ecotemp

4.0

ecotemp + **4.0**

FILTOWER F 200

eco⁺

ecotemp

4.0

ecotemp + **4.0**

FILTOWER D 100

eco⁺

ecotemp

4.0

ecotemp + **4.0**

FILTOWER D 160

eco⁺

ecotemp

4.0

ecotemp + **4.0**

FILTOWER D 200

eco⁺

ecotemp

4.0

ecotemp + **4.0**

FILTOWER L 100

eco⁺

ecotemp

4.0

ecotemp + **4.0**

FILTOWER L 160

eco⁺

ecotemp

4.0

ecotemp + **4.0**

FILTOWER L 200

eco⁺

ecotemp

4.0

ecotemp + **4.0**

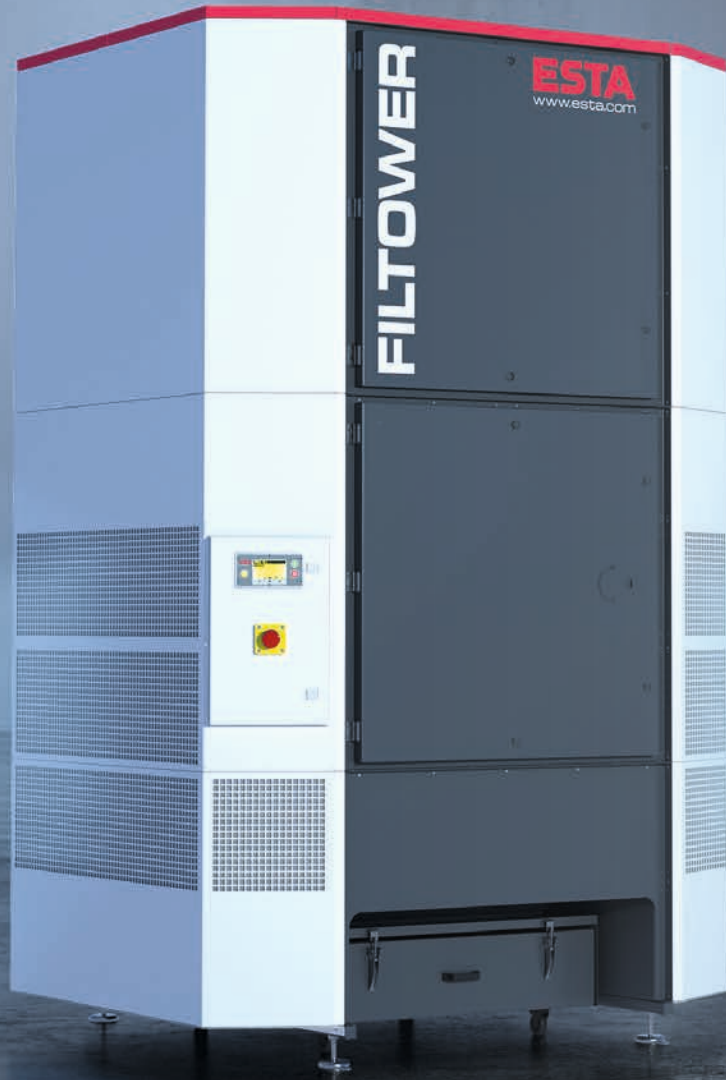

FILTER TOWER

ESTA
www.esta.com



ESTA – the specialist for extraction technology

ESTA extraction technology has been providing comprehensive solutions for all application areas for more than 45 years. From individual devices for a wide variety of purposes to complex extraction systems – we ensure a consistently clean working environment.

This protects machines, serves to keep your employees healthy and creates the conditions for efficient and quality-oriented working.



HIGHEST QUALITY

We manufacture and test our extraction devices and filter systems subject to the strictest quality criteria at our headquarters in Senden (Bavaria).

All our products are certified according to ISO 9001, so we can continuously guarantee you the highest quality.



TECHNOLOGY PIONEER

Our passion is smart extraction technology that meets all your needs.

Through permanent monitoring of the system parameters, the ESTA EasyControl system developed by us allows optimal operation by means of predictive maintenance for example.



45 YEARS OF EXPERTISE

With 45 years of experience and over 125,000 installations and extraction systems worldwide, ESTA is your competent partner for clean air at the workplace. We are one of the leading manufacturers of extraction technology thanks to our wide range of standard equipment, but also our tailor-made solutions.

What sets us apart



RESPONSIBILITY (CSR)

Our primary task to establish a sustainable business, by way of creating, the right balance of economy, ecology and social issues, is our primary task. That's why, for example, we invest continuously in the development of resource-efficient products and are involved in numerous environmental initiatives.



COMPETENT CONSULTING & PLANNING

In addition to comprehensive professional advice, a design that is tailored precisely to your individual requirements is important. Our engineers use state-of-the-art software to produce detailed 3D drawings that are exactly tailored to your application.



AFTER-SALES-SERVICE

The ESTA service team reliably ensures that your extraction system delivers consistently optimal results.



This is guaranteed through our comprehensive after-sale service, such as long term support, a competent maintenance service and an extensive stock of spare parts.

ESTA

THE WORLD OF EXTRACTION



ESTA Extraction USA
8349-K Arrowridge Blvd.
Charlotte, NC 28273
United States of America

 1-833-ESTA-USA
 info@esta-usa.com
 www.esta-usa.com